

Polysulfide Sealants

For Aerospace

**THEIR CHARACTERISTICS AND
METHODS OF USE**



ESSEX CHEMICAL CORPORATION

Polysulfide Sealants

FOR AEROSPACE

THEIR CHARACTERISTICS AND METHODS OF USE

by

Ralph E. Meyer

Aerospace Technical Specialist



ESSEX CHEMICAL CORPORATION

19451 Susana Road
Compton, California 90221
(213) 537-7600

1 Crossman Road South
Sayreville, New Jersey 08872
(201) 727-2100

TABLE OF CONTENTS

	PAGE
I. INTRODUCTION	7
II. POLYSULFIDE SEALANTS: The Binder & the Formulation	8
A. BINDER	
B. THE SEALANT FORMULATION	
III. PROPERTIES REQUIRED OF SEALANTS	10
A. PROPERTIES OF THE UNCURED SYSTEM	
1. Viscosity and Thixotropy	
2. Effect of Processing on Uncured Properties	
B. PROPERTIES OF THE CURING SYSTEM	
C. PROPERTIES OF THE CURED SYSTEM	
D. ENVIRONMENT — ITS EFFECT ON PROPERTIES	
E. SHELF LIFE OF TWO-PART SYSTEMS	
IV. USE AND HANDLING OF SEALANTS	15
A. RECEIVING INSPECTION	
1. Simple Tests to Confirm Acceptability	
a. Appearance	
b. Viscosity	
c. Block Flow	
d. Reactivity	
2. Extensive Tests	
a. Adhesion / Peel Strength	
b. Tensile Strength	
c. Elongation	
3. Receipt of Frozen Tubes	
B. MIXING	
1. Hand Mixing	
2. Machine Mixing	
a. Dasher Mixer	
b. Meter Mix Machine	
C. FREEZING	
D. THAWING	
E. SURFACE PREPARATION	
F. APPLICATION	
Brushable	
Trowelable / Extrudable	
Rollable	
Sprayable	
V. MISCELLANEOUS COMMENTS REGARDING PRACTICES IN INDUSTRY	26
A. SHORT CUTS WHICH SHOULD NOT BE TAKEN.	
B. JUDGEMENTAL ACTIONS WHICH ARE WARRANTED.	
VI. CONCLUSION	29

INDEX — Charts and Illustrations

	PAGE
Figure 1. <i>Polysulfide Curing</i> _____	8
Figure 2. <i>Properties Required of Sealants — Uncured State</i> _____	10
Figure 3. <i>Newtonian Fluid</i> _____	11
Figure 4. <i>Effect of Temperature & Humidity on Work Life and Cure</i> _____	12
Figure 5. <i>Effect of Temperature and Relative Humidity on Work Life</i> _____	12
Figure 6. <i>Temp/Humidity Variation: East Coast Aircraft Plant</i> _____	13
Figure 7. <i>Polysulfide/MnO₂ High Temperature Sealant — Change of Reactivity with Time</i> _____	14
Figure 8. <i>Photo: Meter Mix Machine with 50 Gal. & 5 Gal. Pumps</i> _____	17
Figure 9. <i>Cartridge Filling from Meter/Mix Machine</i> _____	18
Figure 10. <i>Quick Freezing Filled Tubes in Cold Bath</i> _____	18
Figure 11. <i>Quick Freeze</i> _____	18
Figure 12. <i>Surface Preparation</i> _____	20
Figure 13. <i>Sealant Use & Application Techniques</i> _____	21
Figure 14. <i>Application of Brushable Sealant</i> _____	21
Figure 15. <i>Brushable Sealant Applied</i> _____	21
Figure 16. <i>Use of Extrusion Gun</i> _____	22
Figure 17. <i>Fillet Being Applied — Wing Section</i> _____	22
Figure 18. <i>Fillet Being Applied — Fuselage Section</i> _____	22
Figure 19. <i>Sealant Extruded into Remote Area</i> _____	22
Figure 20. <i>Tooling (Feathering) a Fillet</i> _____	22
Figure 21. <i>Laying a Fillet and Tooling</i> _____	22
Figure 22. <i>Tooling</i> _____	23
Figure 23. <i>Faying Surface: Before & After Squeeze Out</i> _____	23
Figure 24. <i>Bead of Sealant to be Spread on Faying Surface</i> _____	24
Figure 25. <i>Spreading Beads of Sealant on Faying Surface</i> _____	24
Figure 26. <i>Filletts (3 Types)</i> _____	24
Figure 27. <i>Sealing Near Vertical Obstructions</i> _____	25
Figure 28. <i>Sealing Individual Fasteners</i> _____	25

I. — INTRODUCTION

Sealants are used primarily to isolate an environment. Hostile or unwanted environments vary widely in type thus the properties of the sealant must be selected for the desired end use. Some examples are the following:

END USE	PROPERTIES DESIRED
Moisture Barrier	Hydrolytic Stability; Nonabsorbing; Nonleaching
Fuel / Solvent Barrier	Solvent Resistance: Nonswelling; Nonleaching
Differential Pressure Barrier	Adhesion; Tensile; Elongation
Vibration/Shock Attenuator	Modulus — Resilience
Acoustical / Thermal Insulator	Flexibility; Thermal Stability; Open Cell Foam in some cases; Self Extinguishing
Electrical Insulator	High dielectric properties: Noncracking
Electrical Conductive Sealant	Conductive; Tensile; Elongation
Aerodynamic Smoothing	Color requirement in addition to tensile; elongation
Void Filler	Shrinkage limits; Resistance to local environmental problems (organic vapors, moisture, etc.)

It must be recognized that the desired protection must be given not only in a static condition but also in the dynamic condition of temperature cycling and aircraft flexure in flight. For example, a 90 foot wing can flex vertically 16 feet under operating conditions. Sealants must possess the tensile strength, elongation, shear strength and resilience to accommodate this movement while doing its assigned task of sealing the aircraft.

Synthetic binders for Aerospace sealants must exhibit resistance to oils, chemicals, water and weathering. Polysulfides are best among the oil resistant elastomers, followed by fluoroelastomers, urethanes and polychloroprene-nitriles.

Urethanes exhibit the best alkaline chemical resistance, followed by the polysulfides. In water Immersion, polysulfides again are best.

In initiating this discussion of sealants it is pertinent to first differentiate between a sealant and an adhesive.

SEALANTS & ADHESIVES	
DEFINITIONS & DISTINCTIONS	
SEALANTS	POLYMERIC MATERIALS PROVIDING ENVIRONMENTAL ISOLATION — 65°F. TO 250°F. (SOME TO 350°F.)
ADHESIVES	MATERIALS TO JOIN TWO SURFACES FOR THE PURPOSE OF LOAD TRANSFER

This working distinction between sealants (environmental isolators) and adhesives (load carriers) has many exceptions but is satisfactory to indicate the basic differences between the two product types.

This discussion will focus on the uncured and cured properties of the polysulfide sealant, the manner in which those properties can be altered, both intentionally and unintentionally, and processing and operational techniques which can aid in realizing the optimum properties of the sealant.

II. — POLYSULFIDE SEALANTS: The Binder and the Formulation

A. THE BINDER

Polysulfide sealants are elastomers which employ an aliphatic (straight chain) binder consisting of linkages of carbon-carbon, carbon-oxygen, carbon-sulphur, and sulphur-sulphur bonds in the backbone. The sulphur linkages are thought to be responsible for the outstanding fuel resistance of the polysulfide sealants. This "binder system" is obtained by sealant formulators as liquid (very gooey) prepolymers from Thiokol Chemical Corp., the only source of polysulfide prepolymers in the world. There are several liquid prepolymers of varying degrees of molecular weight and equivalent weight, which are selected and blended by the formulator to control the degree of crosslinking affecting the stiffness of the final polymer, and the elongation, tensile strength and other properties of the formulated sealant system.

Of the three major catalysts used in a two-part system (manganese dioxide, lead dioxide, dichromates), manganese dioxide, though not the lowest in specific gravity, offers the broadest range of versatility since it itself is quite stable (lead dioxide is less so) and does not require a volatile carrier (dichromates require water). These characteristics of the MnO_2 catalyst permit its use in formulations which will see temperatures on the order of 350°F. whereas lead dioxide and the dichromates are limited to temperatures of less than 250°F.

The polymerization reaction occurs in the following manner: the liquid prepolymer molecules each contain either 2 or 3 reactive -SH groups. An -SH group from each of two molecules will react in the presence of a peroxide to split out water and form a -S-S- bond. This produces either chain extension or crosslinking as shown in Figure 1.

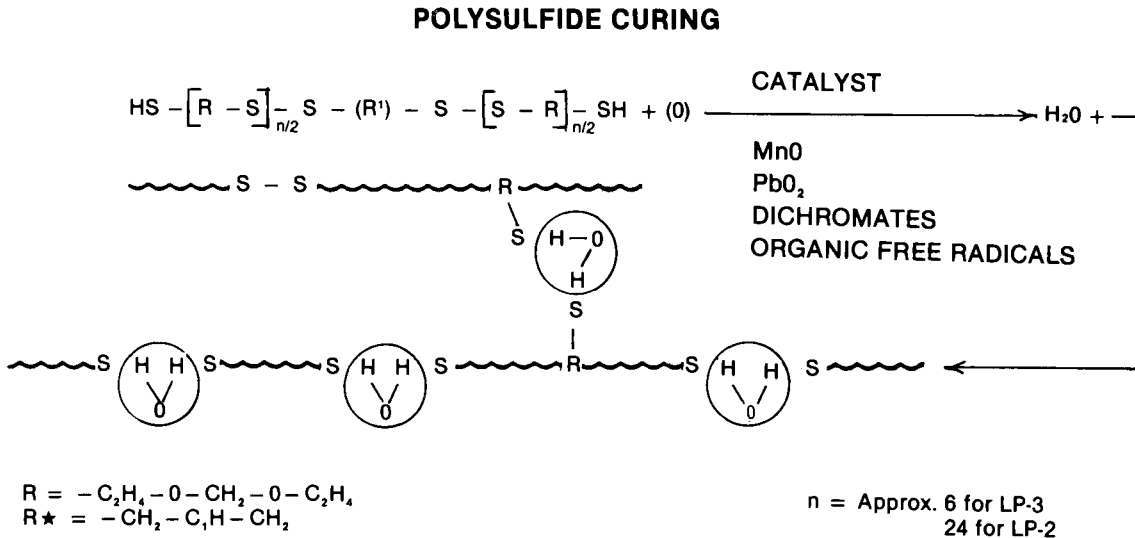

Figure 1

The liquid prepolymer LP-2 for example, has an average molecular weight of approximately 4,000 and has about 2. % crosslinking functionality. LP-32, with a similar molecular weight contains only 0.5% crosslinking functionality. Blends are therefore made to control strength, stiffness and flexibility.

A variety of catalysts are used to cause the polymerization of the polysulfide prepolymer. The major oxidizing agents used are: Manganese dioxide, lead dioxide, chromates, and to a lesser extent cumen hydroperoxide and certain organic free radicals.

B. THE SEALANT FORMULATION

While the polysulfide prepolymer provides the basis for the polymeric binder system in a sealant formulation, a number of other ingredients are used to tailor-make a formulation to the desired uncured and cured properties specified by a customer or class of customers for a specific end use.

FILLERS	Usually various forms of a calcium carbonate, but also may be carbon black, glass or phenolic bubbles (for light weight), metallic oxides, vermiculite, and others. Fillers effect viscosity, hardness, block flow, extrusion rate, thixotropy, elongation, cohesive strength and other properties of the system.
ACCELERATORS & RETARDANTS	Affect the work life and cure rate of the formulation.
ADHESION PROMOTERS	Influence the ability to adhere to many surfaces. Its presence can also effect wettability of the sealant to the surfaces.
PLASTICIZERS	Affect modulus, elongation and other properties. Are used also as vehicles for the catalyst. Excessive use or poor selection can compromise environmental resistance, reduce hardness, and reduce strength.
SOLVENTS	Affect viscosity, flow. Are used to provide desired processing characteristics such as brushability, rollability, sprayability. Introduces shrinkage considerations and "open time" considerations. Methyleneethyl ketone (MEK) and toluene often used.
PIGMENTS	Coloring agents are often required by the customer for a particular end use. Silver color for aerodynamic smoothing, black for certain trim areas, other distinctive colors used to flag special properties (low adhesion; primer coat; etc.). Metallic oxides, carbon black, and other materials are used.
THIXOTROPIC AGENTS	Several types are used to produce nonslumping characteristics while permitting good extrusion rates.

These ingredients produce sealants with properties designed for the aircraft applications mentioned previously and for the special shop requirements of the major Aerospace user.

III. — PROPERTIES REQUIRED OF SEALANTS

Sealant properties are specified in a large bank of government and commercial specifications. Both the cured and uncured properties are specified by users in order to satisfy not only the needs of the end application but also their particular processing and testing practices as well.

Consider then the dilemma faced by the formulator in providing a product line of filleting or faying surface sealants to meet the needs of government (MIL-Specs.) and the not always identical specification requirements of aircraft manufacturers such as Boeing, General Dynamics, Lockheed, McDonnell Douglas, Northrop, Rockwell International, Fairchild and Grumman for essentially the same material. Unfortunately, there are sufficient differences among the specifications to require not only slightly different properties, but acceptance testing under somewhat different conditions and in many cases, on different groups of substrates.

Producing a batch of a particular type of sealant is only the beginning. Decisions must then be made if the batch should be qualified to all specifications or be split into several batches and adjusted to meet a few particular specifications. It can be seen that wisdom, intuition, past history and the aid of customer purchasing plans are necessary to produce a well balanced inventory.

The discussion in this section however will focus on the chemical and physical property requirements placed on the sealants by the end user. Toward this end we will discuss the properties required of the uncured sealant, the sealant during cure, and the properties of the cured sealant. Sealants in the uncured and curing states are chemically reactive thus the formulations must be designed for storage stability at normal temperatures, and they must produce the desired curing characteristics at standard conditions. (77°F. & 50% RH).

A. PROPERTIES OF THE UNCURED SYSTEM

It practically goes without saying that both the base and catalyst sides of the two part sealant, as supplied to the customer in kit form, must be uniform in appearance, no lumps, no skin or other contamination. (Fig. 2)

PROPERTIES REQUIRED OF SEALANTS — Uncured State —

APPEARANCE

NO SKINNING, NO LUMPS, NO CONTAMINATION

VISCOSITY

BASE SIDE

SPRAYABLE	20 — 150 POISE
BRUSHABLE	100 — 400 POISE
ROLLABLE	1,000 — 1,500 POISE
TROWELABLE / EXTRUDABLE	6,000 — 18,000 POISE

CATALYST

APPROXIMATELY
300-800 POISE

Figure 2

Some specifications mention a maximum allowable grit size, as measured with a Hegman gage. Some specifications subjectively mention freedom from air bubbles, although no quantitative method for identifying an excessive amount of air has been established. General practice relies on experienced personnel to make judgemental decisions based upon the appearance of previous material.

1. Viscosity and Thixotropy

The viscosity of the base side is of major interest because four major types of sealants are used: brushable, trowelable or extrudable, rollable, and sprayable. The measurement of viscosity alone as an index of suitability of the trowelable/extrudable type is inadequate. The "B" type extrudable sealant, to be satisfactory, must be essentially nonsag at rest, yet be easily extrudable. An extremely viscous material can be either nonflow or can be self leveling, depending upon the particular material. The nonsag but easily extrudable properties are a display of a combination of the non-Newtonian flow of these pseudo-plastic materials and their thixotropic character.

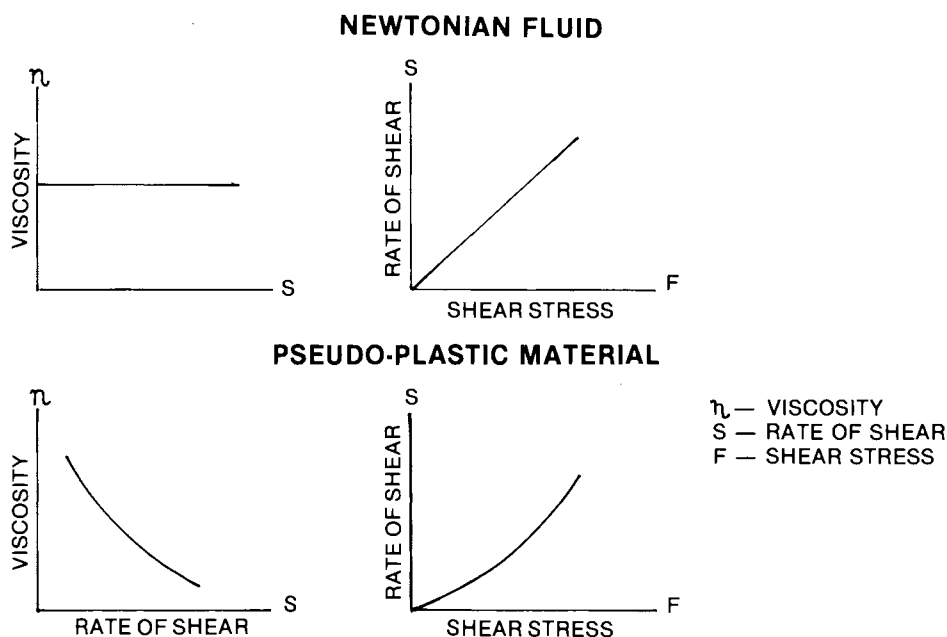

Figure 3

Figure 3 illustrates the differences between the resistance to movement in Newtonian and non-Newtonian (pseudo-plastic) fluids.

Newtonian liquids such as water, petroleum, and mercury exhibit no change in viscosity with increasing rate of shear. In other words, the shear stress per unit area per unit rate of shear remains constant. This being the case, if it is desired to stir the liquid faster, the shearing force must increase in the same proportion.

Such is not the case with non-Newtonian pseudo-plastic materials where the shear stress per unit area per unit rate of shear decreases with increasing rate of shear.

In addition the thixotropic property produces a very loose "structure" which builds up spontaneously if the system is left undisturbed. Such systems show high resistance to deformation in the undisturbed state; once disturbed (by stirring or extrusion pressure) this resistance abates. Solutions of gelatin, or suspensions of bentonite exhibit this behavior. The material at rest will not seek its own level yet is easily stirred. "B" type sealants exhibit this same nonsag behavior.

Materials Engineers are interested in this property since easy extrusion is desired yet the material must be able to hang from a vertical or overhead substrate surface without sagging. They define these properties by specifying three tests (base viscosity, extrusion rate, and block flow) of the catalyzed mixture. Viscosity is the least important — the combination of extrusion rate range and block flow limitations assure that they obtain the thixotropic character. Certain acceptance tests for block flow of the catalyzed base require that periodically, while the block flow specimen is hanging from the jig, the material be removed and the gel disturbed by stirring — then rehung. The ability of the gel to reform quickly and retain the nonsag character is a demonstration of its degree of thixotropy.

2. Effect of Processing on Uncured Properties

Manufacturing techniques can greatly alter the physical (rheological) properties of the uncured base. The temperatures of the raw materials at the time of mixing, the order of addition of the ingredients, the type of mixing equipment and rate of mixing as well as time of mixing between additions all determine the amount of shear or work going into the batch. The amount of shear greatly affects the dispersion of the ingredients, the wetting of the particle surfaces and in some cases the surface polarities. It is quite possible to reduce the viscosity of thixotropic type sealant base compound from, for example, nominally 11,000 poise to 8,000 poise, or a nominally 7,000 poise material to 4,000 poise by high shear and/or high temperature mixing.

B. PROPERTIES OF THE CURING SYSTEM

In order to assure that the worker has the time to apply the sealant and that the sealant cures fast enough or slowly enough to permit necessary aircraft assembly operations to occur, and in order to assure that the material will either flow or not flow at both the beginning and end of the work life, a number of properties are spelled out in specifications for the sealant during cure.

These properties include the following:

- Initial extrusion rate or flow rate.
- A specific work life period, as measured by decreases in extrusion rate or increases in viscosity.
- Block flow (slump) for trowelable type sealants.
- Tack free time.
- Open time and deformability at the end of open time.
- Hardness within a specific time period.

It is important to note that curing tests are conducted under standard conditions of 77°F. ± 2 and 50% R.H. ± 5. Sealants are more reactive at higher temperatures and higher humidities, and less so at low temperatures and humidities (Figures 4 and 5).

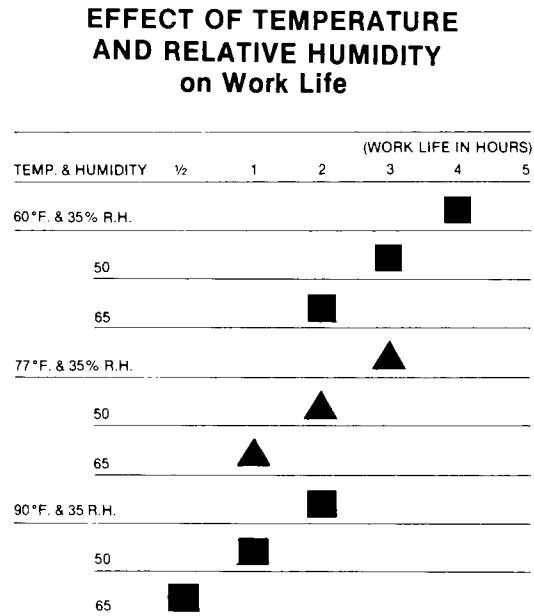
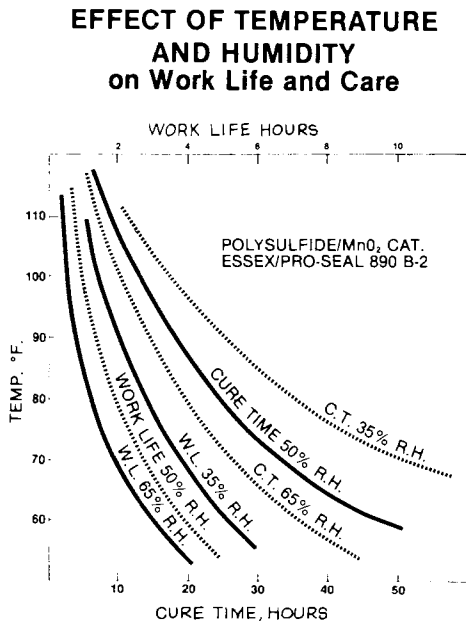

Note, in Fig. 4, at 50% R.H., the work life is three hours at 60°F., 2 hours at 80°F. and 1 hour at 100°F. Example #2, at 80°F. and 35% R.H., the work life is 3 hours, at 50% R.H., 2 hours; at 65% R.H., 1 hour.

Note also the variations in temperature and humidity at an eastern aircraft plant in six months and its effect on cure. (Fig. 6)

TEMPERATURE/HUMIDITY VARIATION
Aircraft Plant — East Coast — 6 Month Period

SEALANT:

MIL-S-8802 TYPE B-2

<u>TEMPERATURE °F.</u>	<u>HUMIDITY (%)</u>	<u>CURE TIME (HRS.)</u>
55	40	100
60	38 - 74	70 - 34
65	55 - 70	40 - 27
70	50 - 80	40 - 24
75	50 - 88	34 - LESS THAN 24
80	60 - 80	LESS THAN 24
85	66 - 80 +	LESS THAN 24

Figure 6

Suffice it to say not only that customer laboratories must be diligent to maintain the standard conditions of temperature and humidity in order to verify the acceptance test results, but even more importantly, the shop users cannot expect the performance observed in the laboratory if the plant temperature is a Kansas 95°F. or a New England 55°F., or the humidity has dropped to a crackling 15% or saturated the atmosphere at 90%. It is therefore of critical importance to the user that he recognize the significant changes in reactivity to be expected with temperature and humidity changes.

C. PROPERTIES OF THE CURED SYSTEM

Aerospace criteria for the cured sealant addresses a wide variety of properties.

Weight limitations are reflected in specific gravity limits. The other attributes (tensile, elongation, hardness, cohesive strength, shear strength) are controlled by acceptance ranges appropriate to the end uses envisioned.

Substrates vary from bare aluminum to three or four forms of treated aluminum plus coatings of polyurethane; glass, polycarbonate and others. The formulator (sealant supplier) makes every attempt to broaden the scope of his sealant to adhere to many surfaces through the inclusion of wetting agents and adhesion promoters, but the user himself ultimately bears a large part of the responsibility for the integrity of the adhesive bond in his shop by the manner in which the surface was cleaned, the temperature and manner in which the sealant is applied and the environment which the sealant sees during and after cure. This subject will be discussed in more detail in the section on surface preparation, application and curing environment.

The cohesive and tensile strength of the material is controllable over a broad range by the formulator through his selection of blends of the liquid polymers, through his choice of the concentration of liquid polymers in the formulation, through his selection of particle size of the filler (smaller particles makes stronger material) and even the character of the surface of the filler particle.

D. ENVIRONMENT — ITS EFFECT ON CURED PROPERTIES

Aircraft, used throughout the world, experience large excursions in temperature not only from climate but also from temperature changes with altitude. From all sources of internal and external heat, the range is -65°F to $+250^{\circ}\text{F}$. With high performance aircraft sometimes even higher temperatures are encountered.

Aircraft bases near the oceans are subjected to a continuous deposition of salt spray.

Jet fuel transported by tankers and barges is often forced out by pumping salt water into tanks displacing (but contaminating) the fuel. This fuel containing salt water eventually is loaded into an aircraft.

Hot, humid climates offer a severe environment for sealants which are not hydrolytically stable.

Under all these conditions the sealant must exhibit good stability without loss of adhesion, without significant loss in cohesive or tensile strength, and without loss of its resiliency. Thus, limits are placed on swelling, weight loss, chalking and other symptoms of degradation.

E. SHELF LIFE OF TWO-PART SYSTEMS

It must be reiterated that uncured sealants are chemically reactive systems. They are "perishable". Both the manufacturer and the user share a responsibility to protect the shelf life of the sealant.

The manufacturer must formulate the most chemically compatible and stable system (i.e. base and catalyst) possible and package it in sealed containers under an inert atmosphere to maximize its shelf life.

The user must recognize the activating effect of temperature and exercise care in his manner of warehousing.

The shelf life quoted on the labels of most sealant suppliers are based on a recommended storage temperature of no more than 80°F . Many warehouses have no air conditioning; temperatures can reach $130-140^{\circ}\text{F}$. in the summer months. The base side of sealants may begin to thicken by slow polymeric growth even without the presence of the catalyst.

Users may double the useful life of the sealant by merely storing the sealants at 60° . instead of 80°F . Further extension of useful life is possible by further reducing the storage temperature. Aging at a fixed temperature results in some change in reactivity. Figure 7 illustrates the expected change as assessed by the Air Force Materials Laboratory and reflected in the MIL-S-83430 for High Temperature Sealant.

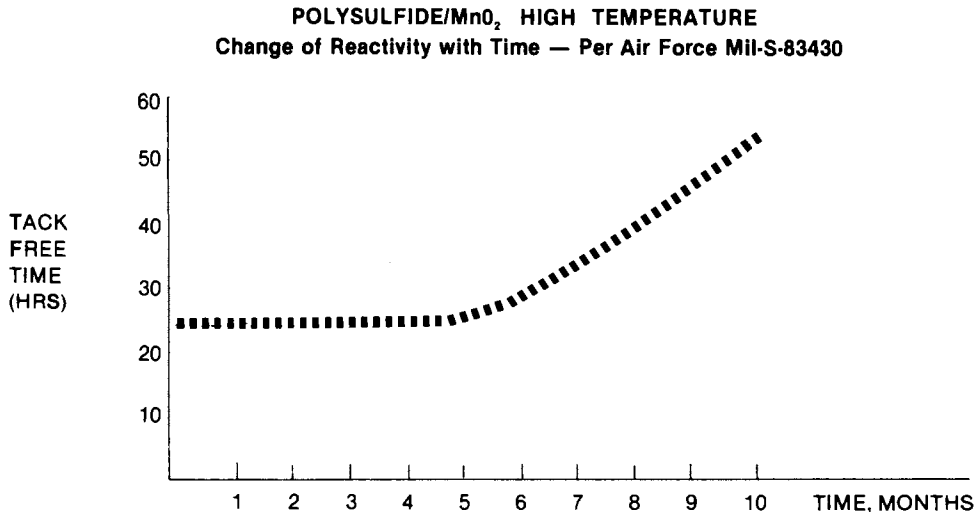

Figure 7

IV. — USE AND HANDLING OF SEALANTS

It is important to highlight the factors which should be considered by the user in the use and handling of the sealants in order to realize optimum performance from the sealant kit supplied.

Brief comments will be offered concerning receiving inspection, storage before use, mixing, mix freezing, thawing and application. Surface preparation will also be discussed. The intent in this discussion is not to give a step by step procedure, but to call attention to critical (sometimes deceptively simple) factors which can greatly effect the results obtained.

A. RECEIVING INSPECTION

Users of sealants display a variety of attitudes toward receiving inspection. Some accept the manufacturer's certification as sufficient and conduct no tests of their own. Others run limited acceptance testing and some run the full range of acceptance tests called for in the specification and occasionally rerun some of the qualifying tests.

1. Simple Tests to Confirm Acceptability

A reasonable list of tests to confirm acceptability would be the following:

a. Appearance:

- Skinning • Contamination • Lumps • Excessive Air • Quantity in the kit

b. Viscosity — Brookfield Viscometer

- Measure Base • Measure Catalyst (after stirring)

c. Block Flow:

Stir catalyst thoroughly before weighing out the desired amount, stir and mix base and catalyst thoroughly.

d. Reactivity:

— Work Life — Note the standard conditions for measuring extrusion rates are 90 psi pressure in sealant gun; cartridge fitted with a 440 nozzle. The temperature of the material should be 77 °F. The sample kit should be preconditioned to this temperature before the mix is made.

— Tack Free — Again, the base and catalyst should be preconditioned to 77 °F. before mixing to permit a time assessment of tack free time @ 77 °F.

— Cure Rate — Stir the catalyst thoroughly before removing the desired weight of material. Mix thoroughly with the base, scraping down the sides of the container and vigorously working the material for 5 min. until uniformity (no streaking) is reached.

Observe standard conditions 77 °F. and 50% R.H. Note that there are two types of hardness gages, Rex and Shore A. The "foot" of the Rex gage has a smaller area and the reading is an instantaneous one. The Shore A reading is taken after 3 sec. or 5 sec. usually, depending upon the spec.

The thickness of the test specimen for measuring hardness is important (minimum thickness, 1/8"; usual thickness is 1/4"). Hardness Shore A and Rex are slightly different, thus attention must be given to the type of instrument used, and the method of taking the measurement.

2. Extensive Tests

a. Adhesion/Peel Strength — This test is usually run on a Scott Tester or an Instron. The selection of the panels, the surface preparation (cleaning) of the panels and the application of the sealant to the panel, working the material into the duck cloth or the metal screen, are all of critical importance to the success of the test.

- **PANELS** — Treated panels with too thin a coating can be a source of adhesion failure. Old panels may have a coating of oxide which may compromise the bond.
 - **SURFACE PREPARATION** — Scrubbing with an alkaline cleaner, followed by solvent cleaning and rinsing is standard procedure.
 - Beware of rags (cleaning pads) which may be treated with silicone for dust collection. It will act as a release agent.
 - Rinse panels after cleaning otherwise the dirt will have just been moved around but not removed. Dry with a clean cloth.
 - Clean panels must be protected from airborne contaminants from sources such as air conditioners, degreasers, spraying booths, exhaust fans.
 - **PREPARATION OF PEEL PANELS** — For stepwise preparation of peel panels see procedure in attachment #1. In summary clean panel, preimpregnate army duck cloth with sealant, place panel in mold, extrude sealant into mold, level, apply impregnated cloth to surface, transfer to deeper mold, apply another layer of sealant, level it, remove from mold; cure. (Generally cure @ elevated temperature: 48 Hr. @ 77°F. + 24 Hr. @ 140°F.).
 - **SOAK TYPE III JET REF. FUEL** — Some suppliers of standard JRF do not meet the requirements. The soak may then be too severe or not severe enough. Analyze purchased material.
- b. **TENSILE STRENGTH** — Dumbbells are cut from 1/8 or 1/4 inch slabs of sealant cured 14 days at room temperature and pulled on a Scott or Instron tester at 2"/min.
- c. **ELONGATION** — The elongation is followed with a scissor-like gage to break. The length at break is compared with original length for elongation data. Tensiles are pull either dry (after cure) or after soak, depending upon the specification.

3. Receipt of Frozen Tubes

If frozen tubes are purchased from a supplier the container should be inspected upon receipt to assure the presence of dry ice, otherwise the work life may have been compromised. The time of receipt and condition should be noted.

Storage before use, in a -40°F. cold box (or colder) will assure no change in properties before use.

Storage at 0°F. causes a slow loss of work life. Class B materials should be stored for no longer than 96 hours @ 0°F. Class A materials should be stored no longer than 48 hours @ 0°F.

Test After thawing:*

- Extrusion rate • Block Flow • Cure • Adhesive (if more extensive testing desired)

B. MIXING

Two-part sealants are supplied in a wide range of kit sizes from the 2½ ounce Semkit and the 1/2 pint 2½ ounce kit to 50 gallon drums plus 5 gallon pails of catalyst. In every case there is a small percentage of extra catalyst included, ranging from 2-10% to compensate for losses in the transfer of the catalyst from its container. Although kit sizes are quoted in terms of volume, the base and catalyst are matched on the basis of weight ratio. Both weight and volume ratios are usually included on the label.

1. Hand Mixing

Generally, kits smaller than 5 gallon are packaged as 3/4 size to allow room in the base compound container to permit addition and stirring of the catalyst.

Use of a rotary can opener which cuts the top ridge off the can facilitates good scrape down of the walls and stirring of catalyst into the base.

If catalyst is to be transferred from a tin container, invert the can before removing the

*Thaw procedure will be discussed in section on use.

top — cut out the bottom then remove the lid. This will allow for easier and more complete removal of the catalyst.

Catalyze the entire kit at one time; use all the catalyst. The insurance that this provides in guaranteeing that the proper ratio is used is far more valuable than the small savings in attempting to weigh out partial quantities to the correct ratio. Some of the hazards of attempting to use partial kits are:

1. Possible use of incorrect ratio.
2. Incorrect weighing.
3. Failure to thoroughly stir the catalyst in the container before removing the desired quantity.
4. Incomplete transfer of base and/or catalyst.
5. Compromise of the remaining material in the kit by failure to supply inert atmosphere or failure to seat the can lid completely.

In all cases it is of paramount importance that the batch of base be catalyzed only with the batch of catalyst to which it was matched. (Batch numbers of matched based & catalyst are given on the label.)

Hand mix thoroughly for approximately 5 minutes with frequent scrape down.

If the storage temperature is greatly different from normal (standard) temperature, the kits should be preconditioned to the standard temperature 77°F.; also local humidity must be on the order of 55% if data sheet performance is expected. Further, if the surface to which the sealant is applied is markedly different from 77°F. the cure rate will vary accordingly. Cycling of the plant temperature day to night and over the weekend will effect the cure rates.

2. Machine Mixing

a. Dasher Mixer/Filler

Small quantities of material are sometimes mixed in a Dasher mixer. A reciprocating screw forces an agitator up and down through the material, mixing it thoroughly without adding air. The top is in contact with the surface of the material. A machine adjustment then converts the agitating screw to a pressure screw forcing the sealed cover into the can and forcing the material out through a port into cartridges for quick freezing.

b. Meter Mix Machines

A photograph of a typical meter mix machine with it's 50 gal. & 5 gal. pumps is shown in Fig. 8.

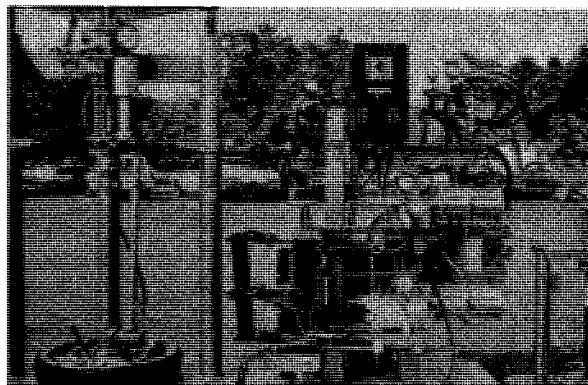

FIGURE 8

Several important points are worth mentioning:

1. Stir the 5 gallon pail of catalyst thoroughly with a mechanical agitator.
2. Do not whip air into the catalyst.
3. Scrap down the walls.
4. If catalyst sits for 48 hours after stirring, stir it again.
5. Either start with clean lines and an empty Meter/Mix machine or purge the lines and machine with at least two gallons of base plus equivalent catalyst.

6. Purge air from the equipment as well as the lines otherwise a large number of tubes will contain air in the mixed sealant.
7. Calibrate a variable ratio machine frequently:
 - Start of each shift
 - Change of containers
8. Collect "Button" samples from each tube (number the tubes). This will reveal unexpected or undetected changes in ratio by differences in cure rate of the buttons.
9. If operations are to be shut down temporarily the mix head can be removed, sealed and frozen. The base and catalyst tubes should be closed.
10. If a static mix head is used, clean it if the flow rate decreases substantially.
11. Air pressure to the meter mix equipment should be sufficient in volume as well as pressure. 60 cu. ft./minute @ 80 psi is standard.

C. FREEZING

Immediately after a tube is filled (Figure 9) from a meter/mix or other type machine it should be quick-frozen (Figures 10 and 11). One standard method is by placing in a cold bath of trichloroethylene and dry ice. The rear end of the tube (from plunger back) should not be submerged. After 30 minutes remove and place in a cold box or cold room at -40°F . or lower to assure no loss of work life in storage will occur. Tubes have been held as long as six months at this temperature without loss of work life.

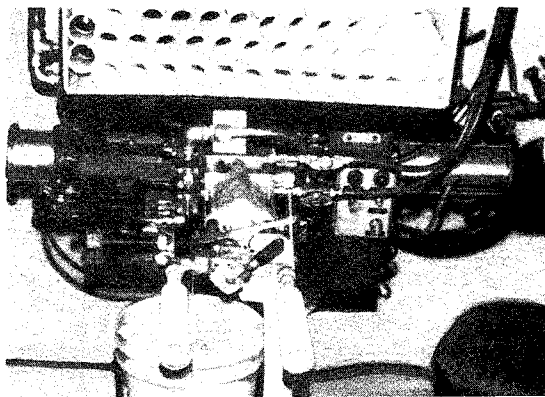

Figure 9

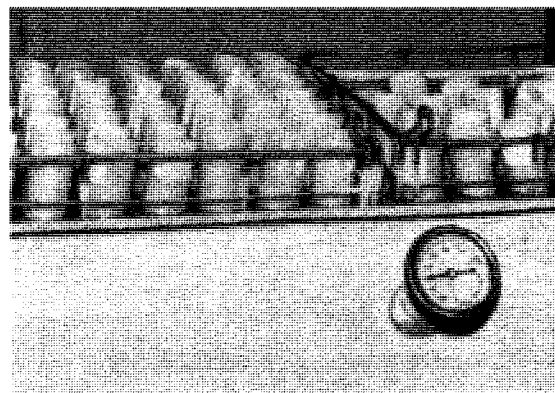

Figure 10

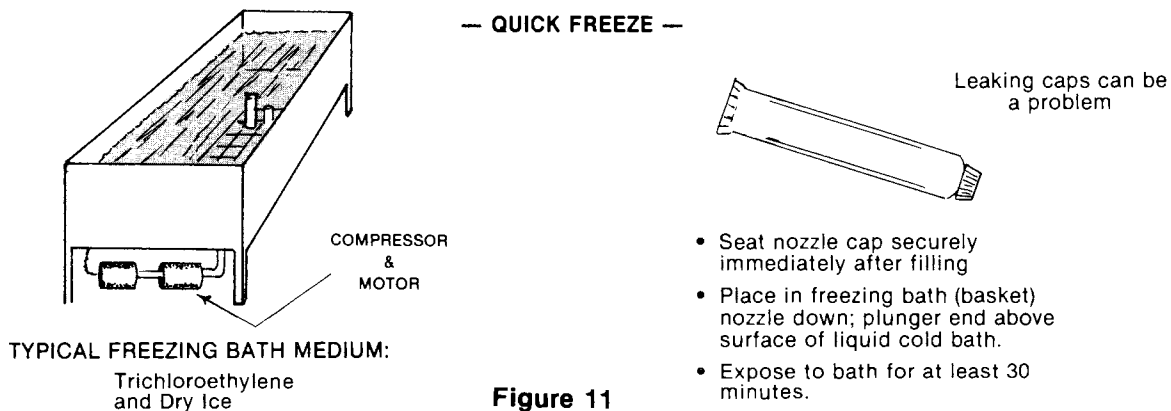

Figure 11

TYPICAL FREEZING BATH MEDIUM:
Trichloroethylene
and Dry Ice

Another approved method of quick freezing is to place the freshly filled tube of sealant into a liquid nitrogen chamber for approximately 2 minutes to reduce temperature to -30°F . or below. Place the frozen tube in a cold box or room at -40°F . Some aircraft companies have set a policy that a frozen tube should not be kept more than 12 days. Most state 3 weeks to a month for polysulfides.

Temporary storage of quick frozen A2 and A4 at 0°F. should be restricted to approximately 48 hours while B2 and B4 can be kept safely for 96 hours. It is not well nor advised to store A½, B¼, B½, B1 at 0°F. for any significant length of time.

D. THAWING

Frozen tubes may be thawed by three methods:

1. Ambient air on bench.
2. Enclosed heating bath (tubes inserted in metal sleeves)
3. Microwave oven

Method #1 is not favored but is widely used. The rate of warm up is variable and slow, depending upon ambient air, the closeness of one tube to the next, whether it is standing vertically or lying horizontally, etc. Ambient thaw usually takes approximately 30 minutes.

Method #2, the enclosed heating bath, offers good control. At 120°F. ± 5°F. the thaw takes about 4 minutes.

Method #3, Microwave Oven: If a carousel microwave oven, 650 watts, with automated interrupted defrost cycle 20 seconds heat/20 seconds soak is used, a tube can be thawed in approximately 2 minutes. This is the most precise method of control. It is appropriate to mention that the oven wattage and heat/soak cycle is directly related to the time required. Carousel or other tube reorientation is required for uniform heat.

In all methods of thawing, less work life will be available than in freshly mixed material. A broad estimate would be that approximately 25% of the work life is lost by freezing and thawing.

E. SURFACE PREPARATION

Good adhesion of the sealant to the substrate is obviously fundamental to the purpose for which sealants are intended. Absence of that bond or partial failure of the bond can result in a lack of isolation of the environment: Intrusion of moisture can cause rusting to occur; if the sealant is used to maintain a barrier between two different pressure levels, the goal would be defeated; bond failure in integral fuel tanks can result in fuel leaks. Good adhesion therefore is a must.

Achieving good adhesion, however, depends as much on the proper condition of the substrate surface as it does on the adhesion characteristics of the sealant. Obviously if sealant were applied to a surface coated with oil, one would not expect to get adhesion. If sealant were applied to a surface coated with dust, one wouldn't expect to get good adhesion. If sealant were applied to a treated or coated plate where the coating was not bonded well, one could expect failure between the coating and the metal surface if sealant were applied to the surface coating and subsequently stressed.

It can be seen that the proper preparation of this surface is as important to the ultimate success in achieving good adhesion as is the proper formulation of the sealant. The end user therefore shares equally with the sealant supplier the responsibility for assuring that a good bond is realized.

The purpose of surface preparation is to ensure that adhesion develops in the joint to the extent that the weakest link is within the adhesive or organic material layer, not at its interface with the adherend.

Unclean surfaces will not be receptive to adhesion regardless of the quality of the sealant used or the exacting control of the application process. Certain other surfaces require special treatment above and beyond mere cleaning. For example, in order for Teflon or other fluorinated polymers to offer a receptive surface they must be chemically etched. (One etching solution for Teflon is a mixture of sodium and naphthalene is tetrahydrofuran). Special surface preparation methods have been created for a wide variety of surface types.

The Aerospace use of polysulfides are concerned for the most part with adhesion to variously treated or coated aluminum surfaces. Aluminum can be anodized, treated with alclad or alodine surfaces, coated with epoxies or polyurethanes as well as other coatings. First, that bond between the aluminum and its coating must be a strong one. The sealer

then has the responsibility of cleaning that surface, the protecting that surface until the sealant is applied.

The most desirable approach is to first clean the aluminum surface with an alkaline (detergent) cleaner to remove the water/detergent soluble contaminants then to follow with organic solvent cleaners such as the MIL-C-28736 solvent cleaner (a mixture of 50% aromatic naphtha (cont. 30 parts Toluene), 20% ethyl acetate, 20% methyl ethyl ketone and 10% isopropyl alcohol) to dissolve the contaminated soluble in organic solvents, then wip dry, wait 30 minutes, and apply the sealant.

An excellent text on this subject is the "Handbook of Surface Preparation" by Richard C. Snogren, Palmerton Publishing Co., NYC, NY.

It is recognized that many of the sealing requirements encountered in the Aerospace industry do not involve "virgin surfaces" but require removal of old sealant, cleaning of the surface and resealing. It is much harder to clean an old surface than a new one and many claim that in spite of thorough cleaning, it is more difficult to get good adhesion to an old surface — all the more reason therefore to do a very thorough cleaning before sealant is applied. Some of the important considerations in cleaning are given in figure 12.

SURFACE PREPARATION

Equipment	Procedure
For Cleaning New and Old Surfaces	
New	1. Place the cleaning liquid in squirt bottle.
• Cheesecloth cleaning pads (many)	2. Squirt liquid onto cheese cloth pad. Scrub; turn and pad frequently.
• Alkaline cleaner	3. Change pads frequently. Squirt cleaning liquid onto pad. Never dip pad into a container of cleaning liquid (It contaminates the cleaning liquid.)
• Organic cleaner	4. When surface appears clean, wet a fresh pad. Give final rinse.
• Squirt bottles for holding the cleaning liquid	5. With a new dry pad, wipe the surface dry; don't allow to evaporate.
• Rubber gloves	
Old Surfaces (after removing old sealant)	
• Stripper	
• Materials mentioned above	
• Implements for removing residual sealant from cracks and crevices:	
Scrapers (wood and plastic)	_____
Brushes (wire and plastic)	Clean from the top downward.
Probes, claws, picks	Clean from the inside to the outside. This avoids recontaminating the surface.
Bendable wire with scraper blade	
Clock spring with scraper blade	
Dental mirror with ball joints	If the sealant is not applied in 24 hrs., clean it again.

Figure 12

Primers — Although primers are not required with polysulfide sealants, many users prefer to apply a primer on the cleaned surface for added adhesion insurance. Essex Pro-Seal 152 is recommended on polyacrylic and polycarbonate surfaces. Again 30 minutes should be allowed before the sealant is applied. If 24 hours has elapsed without application of the sealant, the primer should be reapplied.

F. APPLICATION

There are four basic types of sealant and thus four or five methods of application:

- BRUSHABLE
- TROWELABLE/EXTRUDABLE
- FAYING SURFACE (Rollable/Brushable)
- SPRAYABLE

In all methods of application it is important that complete contact be made with no bridging or absence of sealant.

Brushable sealants are used both as a base coat over which gunnable sealant is applied, and as an overcoat to the gunnable sealant. It is also applied in areas which are not accessible to the sealant gun; and it is used as the primary sealant around metal fasteners or over seams. Sufficient open time should be allowed to permit evaporation of the solvent.

Trowelable/Extrudable sealants are filleting sealants for sealing integral fuel tanks, pressurized cabins, windshields, joints and seams. Aluminumized it is used for Aerodynamic smoothing.

In applying it with a sealant gun, the gun is powered normally by 90 psi plant air. Use of greater pressure may cause a high incidence of flipping (overturning) of the plunger, resulting in air being blown directly through the tube of sealant. Extrusion rate data are based upon this 90 psi delivery pressure, using a #440 nozzle, with the sealant temperature at 77°F.

It is of considerable importance to recognize that the initial extrusion rate of the freshly mixed material is on the order of 70-100 grams/minute. This rate drops steadily to 15 grams per minute at the end of its designated work life. If sealant is to be applied in a remote area through the use of a long necked duckbill nozzle or any other form of long necked nozzle which offers significant flow resistance, a freshly thawed tube should be used to take advantage of the high initial extrusion rate.

Some of the general considerations in the application and use of sealants is given below in Figure 13.

SEALANT USE & APPLICATION TECHNIQUES

1. Before sealing, clean the surface. Wipe cleaners on and wipe them off (with clean rags — no lint)
2. Don't use too much sealant — Messy; hard to clean
3. Clean up any sealant mess as you go.

Use of Sealant Types

1. *Sprayable* — Build thickness by multiple layers, not by heavy spraying.
2. *Brushable* — Apply to a thickness of approx. 1/16" or less. Apply with short, stiff brush. "Work it into surface" with small circular motion.
3. *Extrudable* — Hold sealant gun nearly perpendicular to the surface (approx. 30° off) with nozzle tip pointing in the direction of movement. (See Figure 16). This minimizes air entrapment.
4. *Faying Surface Sealant* — Extrude a bead across the surface then spread uniformly with roller or wide blade to thickness of approx. 10-15 mils.

In using sealants containing volatile solvents, allow time for much of the solvent to evaporate before closing the surface.

Some additional specific techniques are the following:

1. Apply brushable sealant with a short stiff brush. Illustrations of the application of brushable sealant are given in Figures 14 and 15.



Fig. 14 Application of Brushable Sealants

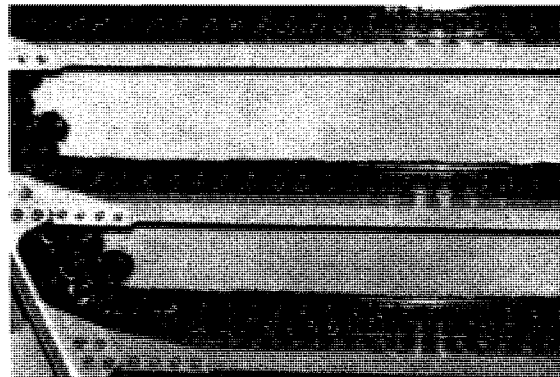

Fig. 15 Brushable Sealant Applied

2. Apply Extrudable sealant from a sealant gun held about 20-30° off the vertical per Figure 16. Examples of extrudable sealant applied on various parts of the aircraft are shown in Figures 17, 18, and 19.

USE OF EXTRUSION GUN

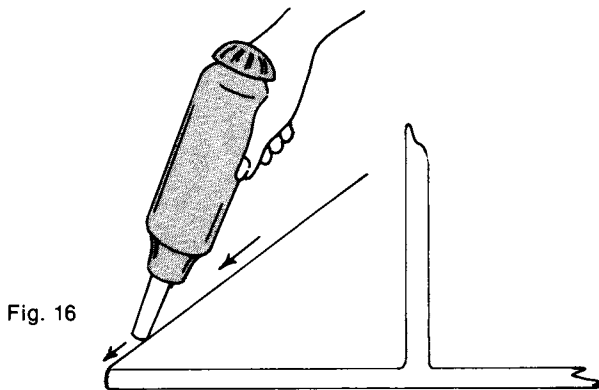

Fig. 16



Fig. 17 *Fillet Being Applied — Wing*

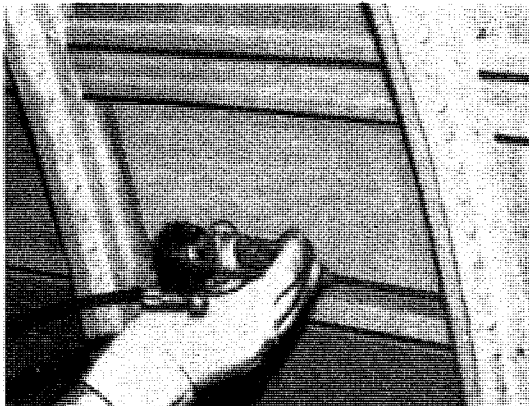

Fig. 18 *Fillet Being Applied — Fuselage*



Fig. 19 *Sealant Extruded into Remote Area*

Fillets should be tooled (Feathered at the edges) as shown in Figures 20, 21, 22.

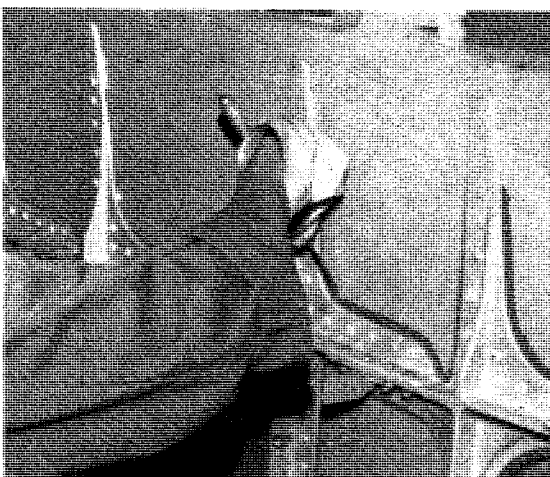

Fig. 20 *Tooling (Feathering) a Fillet*

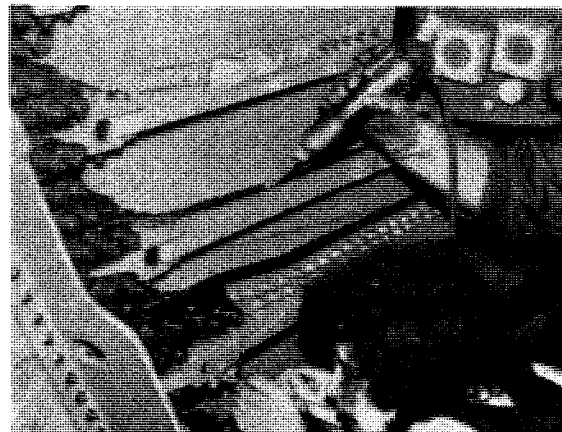

Fig. 21 *Laying a Fillet & Tooling*

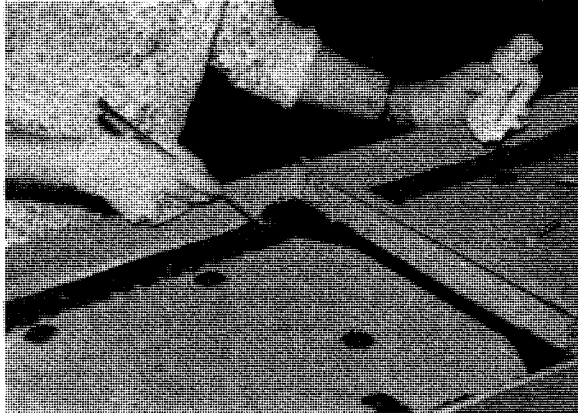

Fig. 22 Tooling

3. Faying surfaces (overlapping metal) must contain a continuous layer of sealant as evidenced by a continuous squeeze out around the edges when the surfaces are fastened together. See Figure 23. Note the sealant is spread on to a thickness of about 15 mils and squeezed out to a thickness of 1.5 mils. The excess is wiped off and a final fillet is put around the edge.

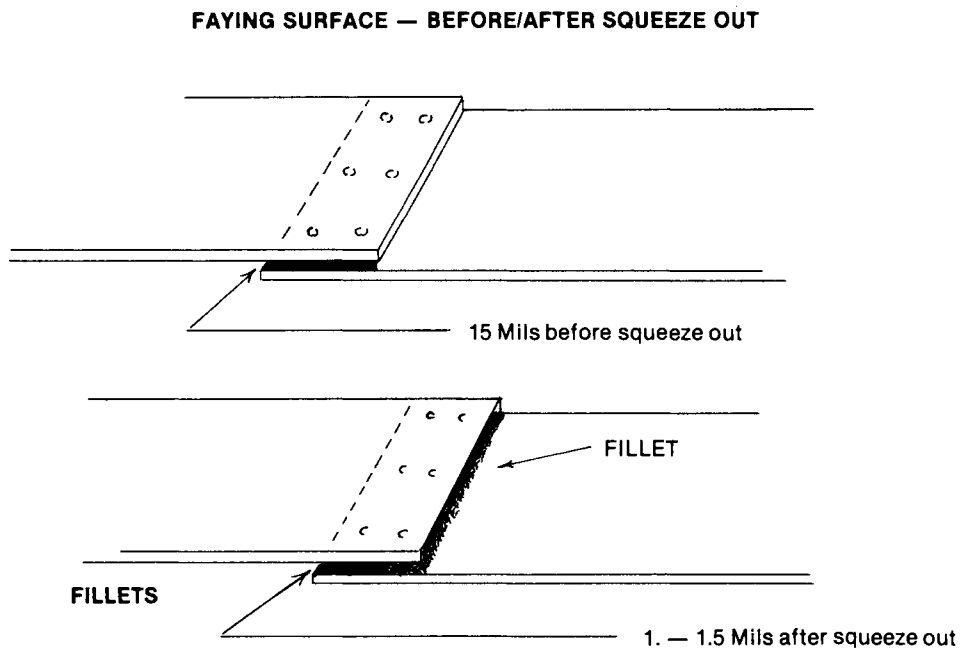

Figure 23

The application of the bead and its subsequent spreading with a broad flat blade is shown in Figures 24 & 25.

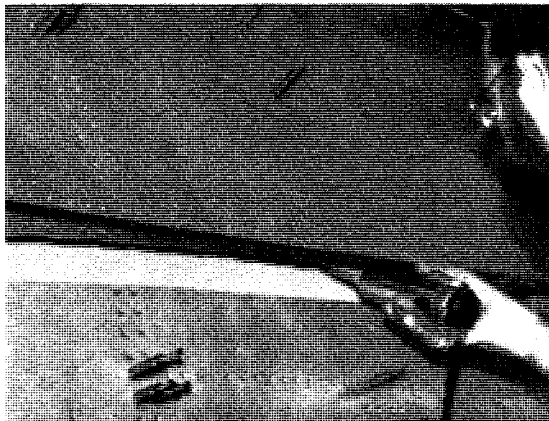

Fig. 24 Bead of Sealant to be Spread on a Faying Surface

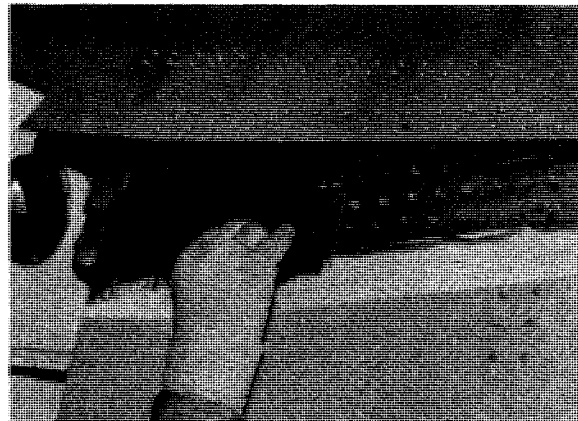

Fig. 25 Spreading Bead of Sealant of Faying Surface

4. Sprayable sealants are used as undercoatings, primers, overcoatings on wing surfaces, fuselage areas and other parts of the aircraft. The sealant must be truly sprayable and not be delivered in "globs". The sealant should be sprayable from the standard air spray gun and airless spray guns as well. Essex Chemical Corporation, offers several varieties.

G. CONSIDERATIONS REGARDING THE CONFIGURATION OF FILLETS

Figure 26 illustrates three types of fillets:

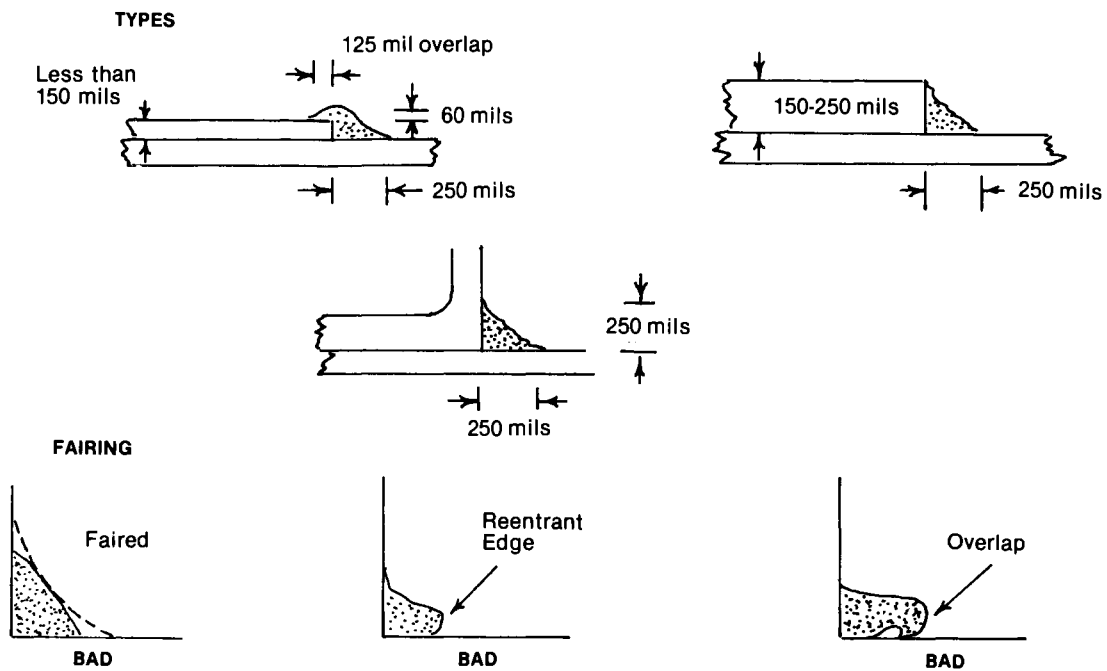

Figure 26

1. The first diagram shows a thin plate (less than 150 mils) overlapped a thicker plate. The edge is sealed by a fillet which overlaps the top of the upper plate with the dimensions shown.
2. The second diagram illustrates that when the upper plate is more than 150 mils thick, a standard fillet (not overlapping) can be laid.
3. The third diagram shows the height to carry the fillet where a vertical member is being sealed at a juncture with a horizontal plate.

Note that in all three cases the sealant is feathered (or "faired") to approximately 250 mils from the potential leak source.

The bottom diagrams in of figure 26 illustrate three bad fillet configurations: (1) No feathering, (2) Reentrant edge and (3) Overlap.

Figure 27 illustrates that if a fastener is closer than 250 mils to a vertical obstruction, the sealant should be filled in solidly to the obstruction and feathered up the vertical.

Figure 28, makes the point that fasteners located more than 500 mils from one another can be sealed individually.

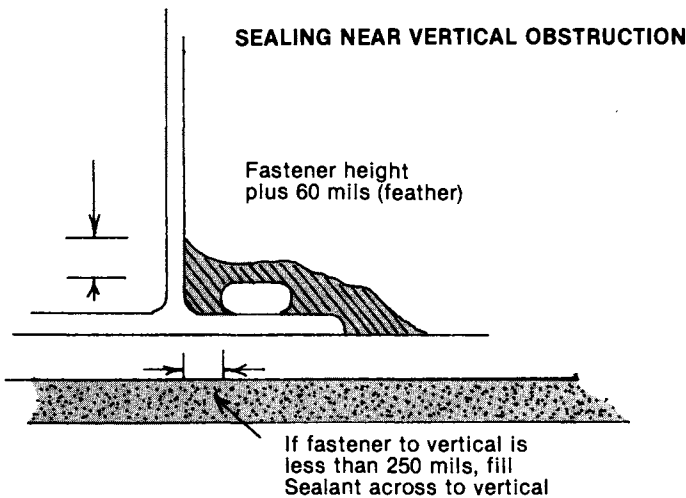

Figure 27

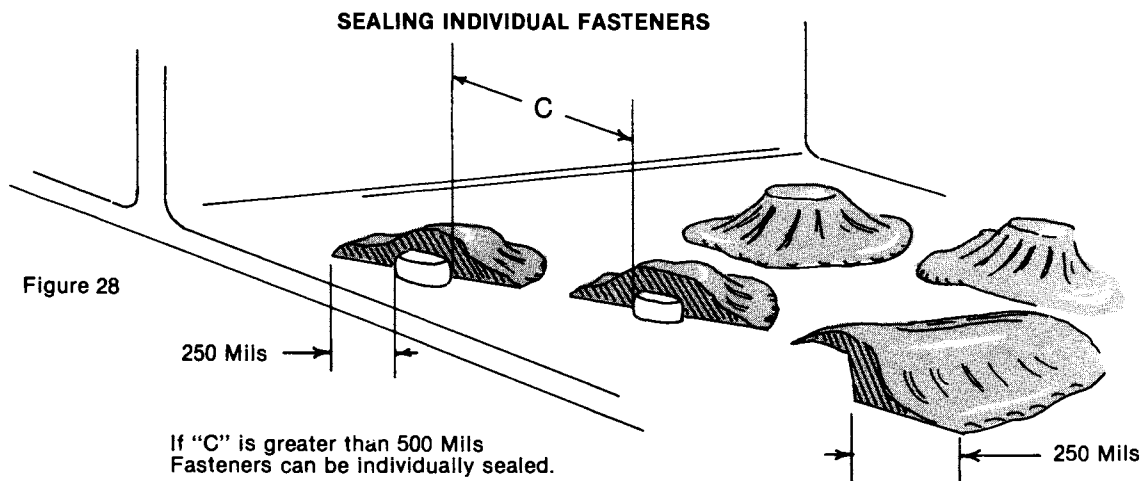

Figure 28

The discussion of the types of sealants available and the methods of application given above present only the basic fundamentals regarding sealants & sealing. It is important to realize that the type of sealant used and its configuration as applied must reflect a recognition of the environment it will experience; not only with regard to temperature, humidity, fuel, salt spray, etc. but also with regard to stress & shear forces resulting from joint movement produced by operation and temperature cycling.

V. — MISCELLANEOUS COMMENTS REGARDING PRACTICES IN INDUSTRY

A. "SHORT CUTS" WHICH SHOULD NOT BE TAKEN

Observations of the use of sealants in many aircraft plants have revealed many practices which compromise the properties of the sealant and/or introduce serious potential sources of failure. Certainly any warranty would be invalidated by the supplier were the condition known to him. Several of the practices are listed below as examples of what not to do. The principal purpose of this discussion has been to emphasize the chemical nature of sealants; as a chemical system, it will respond chemically to whatever environment it meets, whether planned or unplanned. Thus there is a need for careful control of all phases of handling and use.

1. Increasing Catalyst Ratio to Change a B6 to Perform Like a B2

A valving arrangement was improvised on a meter/mix machine to greatly increase the catalyst supplied with a B-6 base to speed up the reactivity rather than change the drum and pail to pump a true B-2 system.

DANGER: Many catalysts use a plasticizer as its vehicle. Overcatalyzing introduces far more plasticizer into the mixed sealant than it is designed to carry. This would tend to reduce modulus, increase elongation, reduce strength, and decrease its resistance to solvents. Leaching out the plasticizer results in shrinkage, loss of cohesive strength and, if over catalyzed to a high enough level — loss of adhesion.

2. Mixing Batches of Catalyst and Base Not Matched to One Another

Every batch of base compound has a catalyst tailor-made to be used with it. The label will read Batch x — use with catalyst Batch y.

There is sufficient variation in the properties of the liquid polymers, and in the particle size distribution and pH of the catalyst that standard formulae alone are not sufficient to produce for example a B2 base compound and catalyst which will meet the extrusion rate, tack free time, cure rate requirements without adjustment. When catalyst is tailored to react with a particular batch of base, it won't produce the same result with a different batch of base.

The user then should be aware of the importance of using the batch of catalyst specifically designed for a particular batch of base compound.

3. Using From the Catalyst Container Without Stirring

The major oxidizing agents used in making sealants are solids. They are suspended, not dissolved, in a liquid vehicle. As a result they settle to the bottom of the container. Our rule of thumb is to always stir the catalyst thoroughly in the container before removing any. If machine meter mixing is used, stir before putting the catalyst on the machine. Then stir again every 48 hours. Some supplier catalysts settle very rapidly and thus must be restirred at even shorter intervals.

4. Establishing the Ratio on a Meter Mix Machine by Color Matching

At one establishment two pieces of 8 x 10 notebook paper were taped to the wall, each with a smear of sealant on it. One said "B2" the other "B6". Colorshade cannot be used as an indication of proper ratio.

5. Inadequate Cleaning of Substrate

A policy or philosophy at one facility was: "We can't spend all day cleaning the surface

— the sealant should be sufficiently forgiving to accommodate a “fairly clean” panel”. This unfortunate approach was further compounded by the expenditure of laboratory time for a series of empirical experiments purporting to identify “forgiving” and “unforgiving” sealants.

Considering the mechanism for adhesion to a surface, the sealant can only adhere to the surface presented to it. If that surface is a film of oil or a layer of powdered oxide, or a precipitated layer of detergent or other residue, the bond strength you are gambling on is the unknown strength of that contaminating film to the sealant on the one hand and the substrate on the other. Further, the subsequent ease of leaching out that film, (if the aircraft component is later exposed to fuel, water or other solvents), is of course totally unknown. Adhesion failure could well result.

6. Altering the Sealant with Additive

The most common practice is to dump in a little or a lot of solvent to thin it down. The risks of course are: Use of contaminated solvents, solvents containing water, solvents incompatible with the sealants; in addition, if the solvent is added to one side or the other before the appropriate weights are taken, the ratio will be changed.

The greatest danger is the sacrifice of the data base of the tested and qualified sealant for the unknown degree of compromise introduced by the untested addition of another ingredient. The Aerospace industry prides itself on control of quality, insisting on qualification, reproducibility and “no change”, to preserve the integrity of their reliability determinations. Such additions for convenience destroy this controlled reliability.

7. Opening a Kit Package Without Using It

Semkits are often packaged in a sealed plastic bag which has been purged with nitrogen. At one facility several thousand kits were opened to insert a square of paper stating when to reinspect. The bags were resealed without purging with nitrogen. All the kits were compromised and the warranties voided.

B. JUDGEMENTAL ACTIONS WHICH ARE WARRANTED

The reasons for unbending loyalty to the written word of the specification is understood when the vision of the opposite extreme is considered. There is a tendency in the Aerospace industry structured by procedures and monitored by company and government inspectors, to follow the word of the specification completely without judgemental decisions (exception is the action of Material Review Boards and the actions of some courageous Materials Engineers); as a result, millions of dollars of good material are thrown away each year or rejected for return and replacement, with all the attendant expenses, when the material could have been used without risk.

Some examples of opportunities for saving time and money are given below:

1. Rejection and Scrapping of Overaged Sealant (Wasteful Most of the Time)

Some companies have established retesting programs for materials whose shelf life has expired. If the results of a few screening tests are good, the shelf life is extended another three months after which the material is again retested. This is good practice and should be encouraged and commended.

2. Rejection and/or Scrapping Due to Presence of Thin Skin

Most specifications read: “There shall be no evidence of skinning . . .”. Many inspectors take this at face value and reject any group of kits represented by a sample which contained a skin.

Assuming the material is within its shelf life, there is sufficient background experience available to know that if the skin is removed, the material beneath it is perfectly good. Other practical problems may be introduced i.e., the time required to remove the skin;

usually the entire skin can be lifted out in one piece with a spatula and work can continue uninterrupted. Many times inspectors will shut down a line with no alternate batches of kits in reserve, merely because a skin has been found on a kit.

3. Automatic Scrapping of Frozen Tubes After 21 Days at - 40°F.

Most specifications allow a shelf life for frozen tubes at - 40°F. to be no more than 3 weeks to one month. Our experience has shown that many frozen polysulfides can be stored for 6 months at - 40°F. without significant loss of work life or other attributes. Some companies are beginning to institute retesting programs. It is believed that users should conduct inexpensive aging studies to be convinced of the longer shelf life available to them and to change their specifications accordingly.

4. Reliance on "Manufacturing Date" as Assurance of Receiving Fresh Material

Test Date should be the base point from which aging is measured. If all data from the test fall within the specification the date that the batch was manufactured is irrelevant.

Several years ago several drums of sealant were discovered in an abandoned warehouse. The labels indicated the sealant was four years old. There was a one inch skin on the surface of the base compound in the sealed drum. The skin was removed and a new catalyst matched, producing material which met every requirement of the specification. Sealant suppliers warrant their material and guarantee the shelf life based on their knowledge of the test date of the batch. This is the only reliable base point. Suppliers warrant the material from the date it is shipped, not the date it was manufactured.

5. Extension of Useful Life by Low Temperature Storage

Some of the more progressive companies are storing their sealants at reduced temperatures to extend the useful life of the kits in inventory. It is well to remember that a reduction of 20°F. in storage temperature cuts the reactivity, or the "aging" in half, essentially doubling its useful life. Significant cost savings can be realized by this technique.

VI. CONCLUSION

It has been the intent of this discussion to highlight key points in the storage and use of sealants which can be helpful in realizing the optimum performance and minimizing opportunities for misuse or waste of the materials. It is hoped that this purpose has been served.

PROCEDURE FOR MAKING PEEL PANELS

1. Avoid air bubbles by machine mixing the sealant. Use either frozen tubes from a meter/mix filling of tubes or use a "Dasher" mixer which precludes the stirring in of air. The tubes can be filled directly from a "Dasher" mixer.
- 2.* If tubes are to be stored before use, use standard procedures for quick freezing and storage. Note: Open end molds are used for applying "B" type sealant to peel panels. Closed end molds are used for "A" type materials. The molds are approximately 3" wide 5" long and 1/8" tall.
3. Place the previously cleaned panel in the mold being careful not to get fingerprints or other contaminants on the plate.
4. Place the thawed tube in the sealant gun; adjust the air pressure to 20-30 psi; do not use a nozzle; extrude the sealant in beads across the 3" dimension laying parallel beads touching one another with no air space in between. Each bead should extend from wall to wall with no air spaces showing.
5. With a flat blade scraper carefully level the sealant letting the scraper glide on the walls of the mold. One pass will be sufficient.
6. Separately impregnate the Army duck cloth in the following manner:
 - a. The Army duck cloth should be cut in strips 2 1/8" wide and 12" long; the number of strips desired (no more than 5 at a time) should be made side by side.
 - b. A bead of sealant should be extruded across the 5 strips at a position approximately 5" from the end.
 - c. Using the flat blade scraper and holding the duck cloth steady, scrape the sealant across the 5 inches of material to the end of the cloth. The pressure on the scraper should permit a thickness of approximately 1/32" to be deposited. This work should be done on a disposable paper so that the 5 pieces of duck cloth can be turned over and the process repeated on the same 5" of material impregnating the other side in the same manner.
7. The impregnated portion of the cloth is then placed carefully on the levelled mold with care being taken to avoid the entrapment of air.
8. Using the flat blade scraper and holding the loose end of the cloth, draw the scraper across the mold to level it once again.
9. Transfer the panels to a second jig which is of the seam width and length but which possess 1/4" walls rather than the 1/8" walls of the previous mold.
10. Add a top of coat of sealant by extruding the bead crossways side by side until the mold is filled.
11. Level it with the scraper, steadying it by holding the cloth at the far end. Remove the peel panel from the mold and cure it in accordance with the required specifications. Generally peel panels are cured with a room temperature and elevated temperature schedule. The most frequently used schedule is: 48 hours @ 77°F. followed by 24 hours @ 140°F.
12. After the panels are cured remove the panels from the oven, cool to room temperature and, if dry peel values are desired, pull the peel panels on the appropriate testing machine. If the panels must be soaked before pulling, transfer the peel panels to the appropriate soaking medium and begin the soak schedule per specification requirements.
13. After soak remove the peel panels, cool to room temperature and pull.

*In setting up the mold for the preparation of peel panels the mold can be anchored to a strong piece of paper by masking tape and the paper anchored to the table top. This minimizes or prevents mold movement during the application of the sealant and during the levelling process.